



Victorian Certificate of Education 2013

General Achievement Test

Wednesday 12 June 2013

Reading time: 10.00 am to 10.15 am (15 minutes)

Writing time: 10.15 am to 1.15 pm (3 hours)

QUESTION BOOK

Structure of book

<i>Type of questions</i>	<i>Number of questions to be answered</i>	<i>Suggested times (minutes)</i>	<i>Suggested time allocation</i>
Writing Task 1	1	30	10.15 – 10.45
Writing Task 2	1	30	10.45 – 11.15
Multiple-choice questions	70	120	11.15 – 1.15

- Students are permitted to bring into the examination room: pens, pencils, highlighters, erasers, sharpeners, rulers, and an English and/or bilingual dictionary.
- Students are NOT permitted to bring into the examination room: blank sheets of paper and/or white out liquid/tape.
- No calculator is allowed in this examination.

Materials supplied

- Question book of 35 pages.
- Answer book for **both** Writing Task 1 and Writing Task 2.
- Answer page for multiple-choice questions on page 15 of the answer book.

Instructions

- Write your **student number** and **student name** on the answer book.
- Write your **student name** on the answer page for multiple-choice questions on page 15 of the answer book.
- Follow the times suggested for each task.
- You may complete tasks in any order and you may return to any task at any time.
- Do not waste time on one particular multiple-choice question. If you find a question very difficult, return to it later.
- Answer all questions.
- All written responses must be in English.

At the end of the test

- You may keep this question book.

Students are NOT permitted to bring mobile phones and/or any other unauthorised electronic devices into the examination room.

WRITING TASK 1

To be answered in the answer book in pen, not pencil. You are advised to allocate 30 minutes to this task.

Consider the information on these two pages.

Develop a piece of writing presenting the main information in the material. You should **not** present an argument.

Your piece will be judged on:

- how well you organise and present your understanding of the material,
- your ability to communicate the information effectively, and
- how clearly you express yourself.

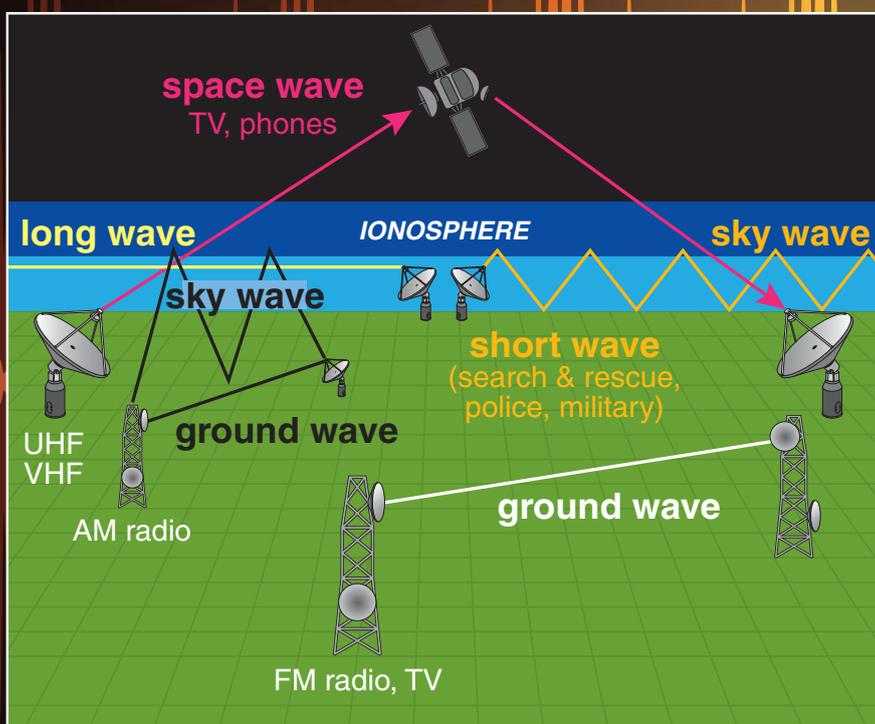

A U.S. Coast Guard Rescue Swimmer radios to the crew of a helicopter during a search and rescue mission.

Due to copyright restriction, this material is not supplied.

THE PARKES RADIO TELESCOPE, NEW SOUTH WALES ESTABLISHED 1961

- received and broadcast the Apollo 11 moon landing pictures, 1969
- acted as back-up tracking for the 2012 *Curiosity* Rover mission to Mars
- discovered over half the known number of pulsars
- has been a major instrument in SETI (Search for ExtraTerrestrial Intelligence)

1896
Radio
patented
by Marconi

Average time spent per week by Australians using media 2010

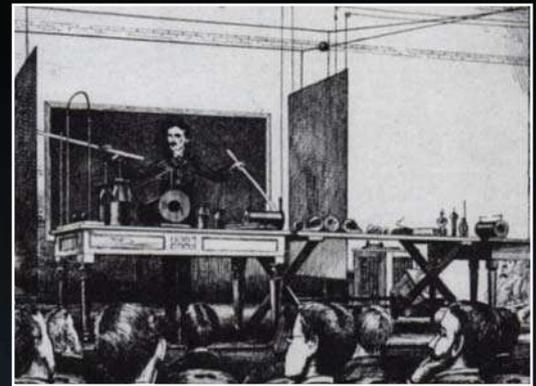
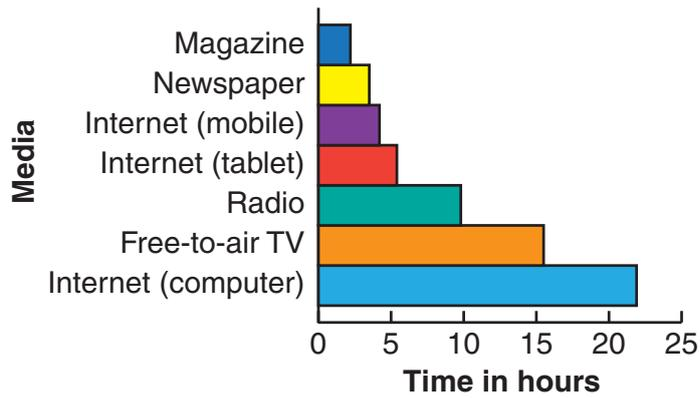

Nikola Tesla demonstrating wireless transmission of power and high frequency energy at Columbia College, New York, in 1891.

Due to copyright restriction, this material is not supplied.

Digital radio – information transmitted as a digital signal, providing perfect sound quality.

Internet radio or webcasting – audio services transmitted via the Internet.

AM radio – broadcasting using Amplitude Modulation: the first method of impressing sound on a radio signal and still widely used today.

Radio – the wireless transmission of signals through space by electromagnetic radiation in the radio frequency range.

FM radio – broadcasting using Frequency Modulation: provides higher quality sound than AM radio.

Podcasts – digital radio files downloaded or streamed online to a computer or mobile device.



1928
Royal Flying Doctor Service begins in Australia

1951
Australian School of the Air begins

1975
Community Radio begins transmission

1988
Indigenous Radio begins transmission

1923
First radio broadcast in Australia

1932
The ABC begins transmission

1950s–60s
rock 'n' roll played on radio

1980
SBS Television begins transmission

2001
Radio online and webcasting begins

2012
Curiosity Rover pictures from Mars

WRITING TASK 2

*To be answered in the answer book in pen, not pencil.
You are advised to allocate 30 minutes to this task.*

Consider the statements below.

Based on **one** or **more** of the statements, develop a piece of writing presenting your point of view.

Your piece of writing will be judged on:

- the extent to which you develop your point of view in a reasonable and convincing way, and
- how effectively you express yourself.

With age come experience, understanding and insight.

‘There is no fool like an old fool.’

Older people ought to retire and let younger people with ideas and energy into the workforce.

The young have as much to teach the old as the old have to teach the young.

MULTIPLE-CHOICE QUESTIONS

*Answer this section in the GAT ANSWER BOOK.
Mark your answers on the Multiple-Choice Answer Page.*

You are advised to allocate 2 hours to this task.

Choose the response that is **correct**, or that **best answers the question**, and shade the square on the answer page for multiple-choice questions according to the instructions on that page.

A correct answer is worth 1 mark, an incorrect answer is worth 0 marks. No marks will be given if more than one answer is shown for any question. Marks will **not** be deducted for incorrect answers.

UNIT 1

Question 1



"We've been thinking a lot about what we want to do with your life."

- 1 The parents in this cartoon could best be described as
- A cautiously thoughtful.
 - B anxiously overprotective.
 - C progressive and enlightened.
 - D presumptuous and condescending.

UNIT 3

Questions 6 – 10

The following quotations are about leadership.

<p>I When the effective leader is finished with his work, the people say it happened naturally. <i>Lao Tse</i></p>	<p>III Nearly all men can stand adversity, but if you want to test a man's character, give him power. <i>Attributed to Abraham Lincoln</i></p>
<p>II To be a leader of men one must turn one's back on men. <i>Havelock Ellis</i></p>	<p>IV Leadership ... the art of getting someone else to do something you want done because he wants to do it. <i>Dwight D. Eisenhower</i></p>

- 6 Quotation **I** and Quotation **II** both portray leadership as
- A an impossible ideal.
 - B somewhat counter-intuitive.
 - C disagreeable and undesirable.
 - D uncomplicated and straightforward.
- 7 Which dimension of leadership does Quotation **III** emphasise?
- A ethics
 - B theory
 - C strategy
 - D procedure
- 8 Compared with Quotation **I**, Quotation **II** is
- A more diagnostic than prescriptive.
 - B more prescriptive than diagnostic.
 - C neither diagnostic nor prescriptive.
 - D both diagnostic and prescriptive.
- 9 Quotation **IV** suggests that leadership is characterised by
- A altruism.
 - B self-delusion.
 - C hidden contempt.
 - D benign manipulation.
- 10 'He who would rule must hear and be deaf, see and be blind.'
- German Proverb*
- Which of the quotations above has most in common with this quotation?
- A **I**
 - B **II**
 - C **III**
 - D **IV**

UNIT 4

Questions 11 and 12

The painting below was painted by John Brack in the 1950s. He said that it depicts 'a social phenomenon important in our time – the family making an afternoon trip from the city to the nearby country on Sunday'.



- 11 The family in this painting is depicted as
- A superior and arrogant.
 - B anxious and unassuming.
 - C carefree and adventurous.
 - D conventional and self-contained.
- 12 In relation to the countryside they are travelling through, the family seems to
- A find it tedious.
 - B find it energising.
 - C be remote from it.
 - D be threatened by it.

UNIT 5

Questions 13 – 16

Over the years, chrome yellow, a pigment used in some late 19th Century and early 20th Century paintings, turns brown. For example, the chrome yellow areas in *Sunflowers*, a painting by Vincent van Gogh, have discoloured over time. Chrome yellow contains chromium (VI).

However, not all paintings using chrome yellow have discoloured. For example, the chrome yellow areas in a painting called *Bathers* by Georges Seurat have not discoloured. Scientific evidence shows that the chrome yellow paint:

- used by both painters contained lead (II)
- used by Vincent van Gogh also contained barium and sulfate
- used by Seurat did not contain barium or sulfate.

•••••

Sophie set up an experiment to test whether the presence of any one of lead (II), sulfate or barium, or some combination of them, in the paint causes chromium (VI) to react and discolour in the presence of light. She prepared eight samples as shown in the figure. Each sample was artificially aged under ultraviolet light (which accelerates the ageing process).

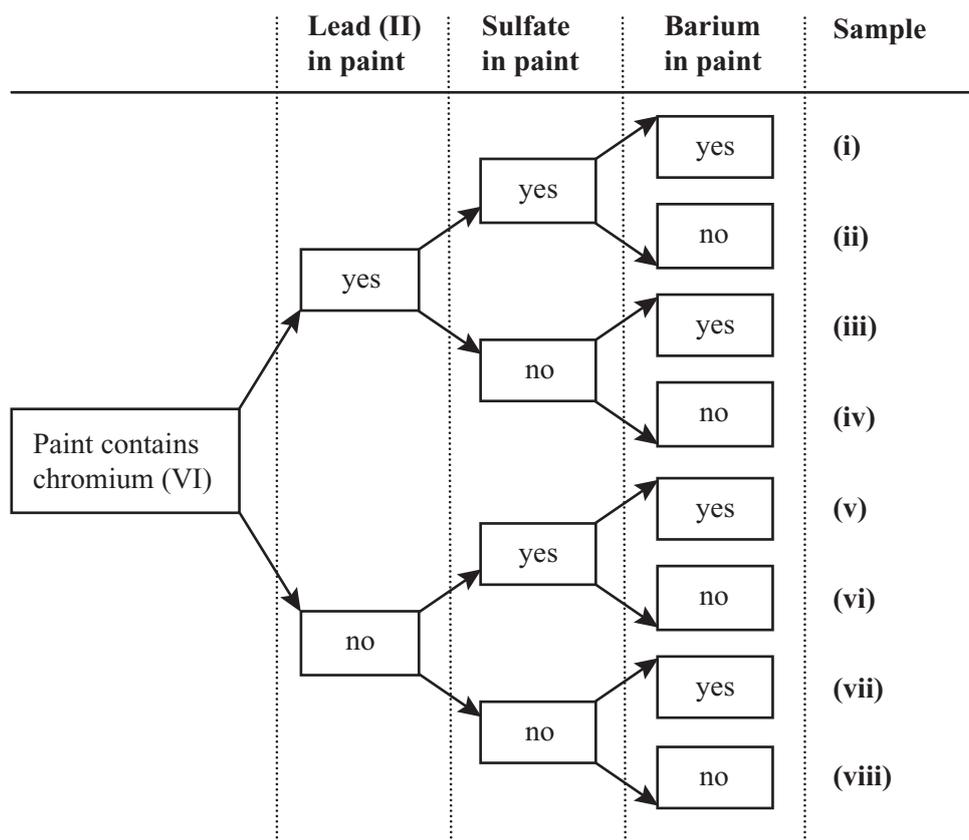

- 13 Which of the samples most likely corresponds to the chrome yellow used in *Sunflowers* and *Bathers*?

	Sunflowers	Bathers
A	(i)	(iii)
B	(i)	(iv)
C	(ii)	(iii)
D	(ii)	(iv)

- 14 If only samples (i) and (v) turn brown, the presence of which of the following most likely caused the discolouration?

- A just barium
- B just sulfate
- C either barium or sulfate
- D barium and sulfate together

- 15 Based on the condition of the chrome yellow in the paintings *Sunflowers* and *Bathers*, which of the samples will definitely turn brown?

- A just sample (i)
- B just samples (i) and (v)
- C just samples (i), (iii) and (v)
- D all samples except sample (viii)

- 16 Suppose that samples (i) and (vi) turn brown but sample (vii) remains yellow.

Which of the following could be best concluded **just** from the comparison of samples (i), (vi) and (vii)?

- A The presence of sulfate turns the paint brown.
- B The absence of barium turns the paint brown.
- C The presence of sulfate and the absence of barium together turn the paint brown.
- D The absence of sulfate and the presence of barium together turn the paint brown.

UNIT 6

Questions 17 – 21

Stock markets around the world now trade stocks and shares using computer systems. These systems can decide the timing, size and price of orders to buy or sell, and increasingly do so without human involvement. The method is known as 'robot trading' or 'algorithmic ('algo') trading' because the programs are driven by sophisticated algorithms, which determine the computers' processes.

'High Frequency Trading' (HFT) is a widely used form of algorithmic trading. It relies on fast processing of complex information. Computers make decisions faster than a human operator can even follow – in thousandths, even millionths of a second. High frequency traders may make multiple thousands of transactions in a day; non-HFT traders more often work out strategies over days or months. HFT works by computers responding to set patterns and movements in the stock market, aiming to make very small profits consistently on high volumes of trades. 5

Because HFT relies on the speed with which computers can get and act on information, some HFT firms pay high prices to place their machines close to stock exchanges, to reduce cabling. Traders physically distant from the market go to extraordinary lengths to gain a small but critical advantage. One cable provider drilled holes through a mountain to set up a link which kept the cable line straight. It cost US\$300 million and cut 1.3 milliseconds off the fastest time for data transfer. The owner was able to charge HFT firms ten times more than other providers. 10

Supporters of HFT argue that it promotes 'liquidity' – in this context, the regular flow of buying and selling necessary for the market's efficient and profitable operation. 15

The need for increasingly sophisticated algorithms has led to breathtaking innovations. But some argue it has turned the stock market into a casino, with the algorithms ensuring consistent and predictable profits, without any 'practical' knowledge of the market. People who argue for greater regulation often refer to the 2010 'Flash Crash', in which the US stock market suddenly lost a staggering 9% of its value, but recovered within minutes. Some believe that it was the result of HFT – it's almost impossible to know, since trading firms closely guard their algorithms. 20

In another case a firm was testing an algorithm that accidentally went 'live', causing chaos in the market. Smaller traders argue also that only big firms can afford to be competitive in the new market. Many are calling for more regulation on algo trading, and for safety measures which would prevent a repeat of the Flash Crash. 25

17 HFT is designed to operate by

- A profit accumulation.
- B taking increasingly large risks on increasingly large transactions.
- C increasing the amount of profit made on individual transactions.
- D allowing non-HFT traders to develop their strategies more quickly.

- 18 The writer suggests that HFT relies on the market's
- A limitless growth.
 - B essential predictability.
 - C fundamental instability.
 - D propensity for corruption.
- 19 The importance of speed (line 8) in HFT reflects the need to
- A diversify the kinds of shares traded.
 - B anticipate other traders in the market.
 - C trade only in the cheapest available shares.
 - D trade only in the most expensive available shares.
- 20 Which impression of HFT are its opponents promoting in their image of the stock market as a 'casino' (line 18)?
- A that HFT creates big winners but also big losers
 - B that HFT firms have to rely on good luck to get results
 - C that HFT is a means of guaranteeing profits to its operators
 - D that HFT seems to offer quick profits but in reality is a waste of money
- 21 What is the point of view that the writer of the article holds on HFT?
- A It is a bold experiment that has failed.
 - B It is a small, specialised corner of the wider market.
 - C It represents a case of innovation preceding regulation.
 - D It is the beginning of the decline of stock markets into irrelevance.

UNIT 7

Questions 22 – 25

Consider the sequence of figures below. Each figure has a specific shape and shading pattern.

Table 1

Position	1	2	3	4	5	6	7	8	9	10	11
Figure						?					?

The first figure (the white rectangle in Position 1) was randomly generated by a computer. Starting with this figure, the remaining figures were generated according to the rules given in Flow charts I and II. Flow chart I is used to determine the shape of the next figure based on the current figure's shape (and sometimes its shading/pattern). Flow chart II is used to determine the shading/pattern of the next figure based on the shading/pattern (and sometimes shape) of the current figure.

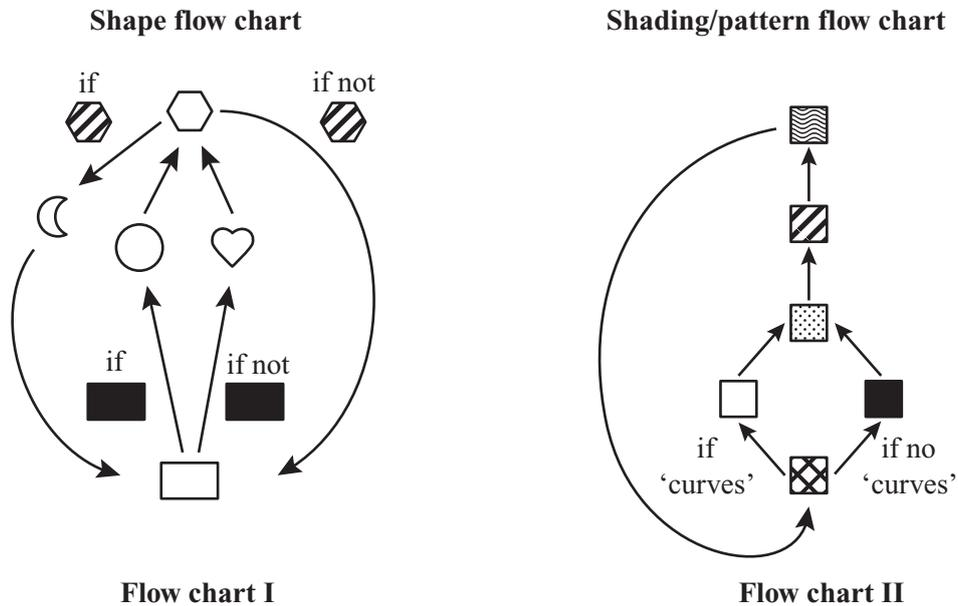

For example, according to Flow chart I, since there is a white rectangle in Position 1 of the above sequence, Position 2 must have a heart, rather than a circle, because the rectangle is white and not black. According to Flow chart II, since Position 1 has a white figure, Position 2 must have a figure with this pattern

- Note that the figures with 'curves' are , and .

22 Which of the following figures should replace the question mark in Position 6 of the sequence in Table 1?

- A B C D

23 Consider this sequence of shapes for which the shadings/patterns have not been shown.

Position	1	2	3	4	5	6	7	8	9
Figure									

If  is in Position 5, which of the following is true?

- | | Position 4 | Position 7 |
|---|---|---|
| A |  |  |
| B |  |  |
| C |  |  |
| D |  |  |

24 If  was in Position 2 in a sequence, which of the following could be in Position 1?

- A any hexagon except 
- B  only
- C  only
- D  only

25 Consider the following sequence of four figures, in which a white hexagon is in Position 1.

 P Q R

Which of the following figures would also be followed by the same P, Q and R?

- A only 
- B only 
- C only 
- D any of ,  and 

UNIT 8

Questions 26 – 28

The diagram below charts the results of a United States program to train police and firefighters to use defibrillators (electric shock devices) on patients whose hearts are in ventricular fibrillation (VF), i.e. in danger of stopping. Their results are compared with local paramedics already using defibrillators.

Below the diagram is a statement by the police department involved in the program. In the questions that follow, the terms ‘survive’, ‘survivors’ and ‘survival’ are used in the special sense defined in this statement.

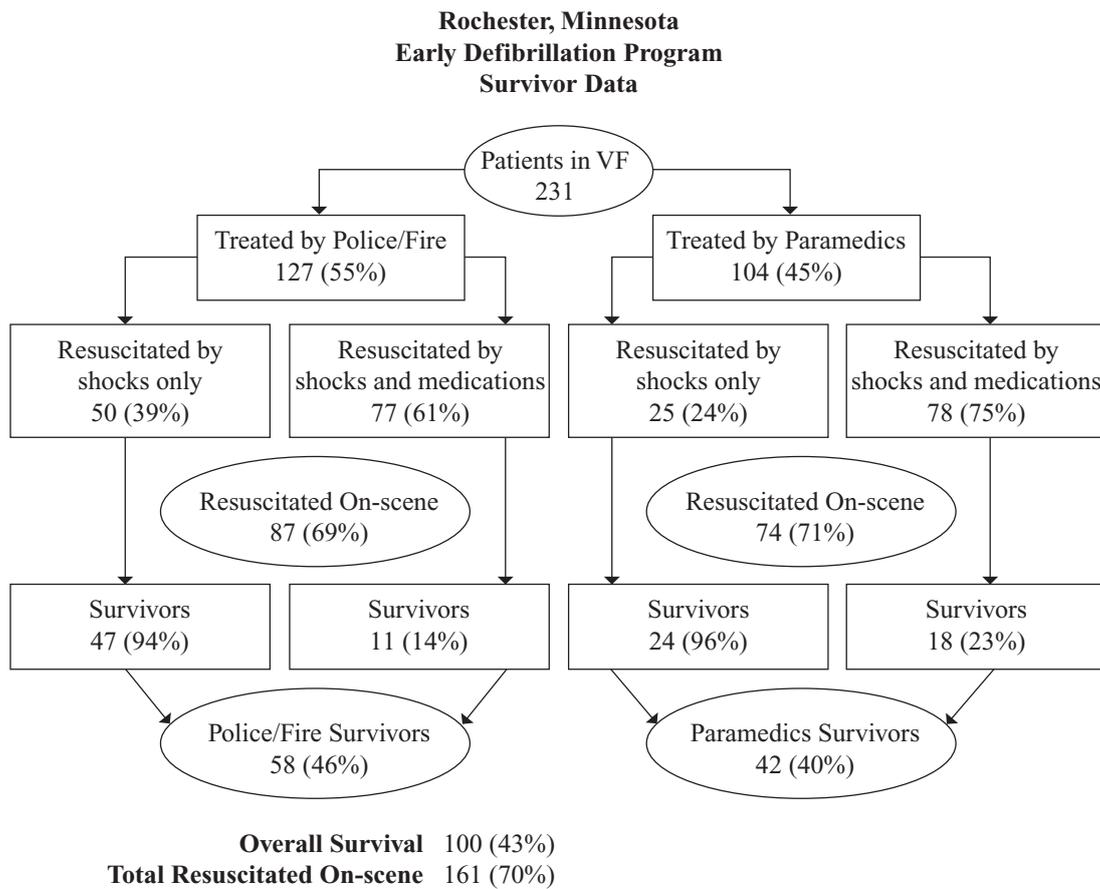

We were able to increase patient survival from 30% up to 43% – which is coincidentally a 43% improvement. It should be noted that the number of survivors includes only those patients who are discharged from the hospital without substantial lifestyle impairments. They may have received a variety of medical treatments or procedures but still enjoy reasonably unimpaired lifestyles after discharge.

- 26 The diagram suggests that patients in VF who were ‘Resuscitated On-scene’
- A went on to survive.
 - B did not necessarily survive.
 - C required medications to survive.
 - D would have survived without being shocked.
- 27 The diagram suggests that ‘Survivors’ are most likely to be patients who
- A require shocks only.
 - B are treated by Paramedics.
 - C are given shocks and medications by Police/Fire.
 - D are given shocks and medications by Paramedics.
- 28 Which one of the following is the most plausible explanation as to why the Police/Fire survivor rate is higher than that of Paramedics?
- A Paramedics did not resuscitate ‘by shocks only’ as much as they could have.
 - B Patients treated by Police/Fire were likely to survive with or without defibrillation.
 - C Police/Fire gave their patients fewer medications than Paramedics gave their patients.
 - D Patients treated by Paramedics suffered more severe VF than patients treated by Police/Fire.

UNIT 9

Questions 29 – 32

The effect of three supplements (**S1**, **S2**, **S3**) on the growth of a species of flowering plant was investigated over a month. Results are given in the table. The presence of a supplement is indicated by a '+'. The results were ordered according to the height to which the plants grew.

Trial Number	S1	S2	S3	Height (cm)
14	+	+	-	59
13	+	+	-	60
7	-	+	+	70
8	-	+	+	71
16	+	+	+	79
2	-	-	-	80
15	+	+	+	80
1	-	-	-	81
6	-	+	-	89
3	-	-	+	90
9	+	-	-	90
5	-	+	-	91
10	+	-	-	91
4	-	-	+	91
11	+	-	+	100
12	+	-	+	101

- Except for the presence or absence of a supplement, the plants used and all conditions were identical for all trials.
- In the questions, an increase or decrease in growth refers to a comparison with normal growth (i.e. when no supplements were provided).

29 Which of the following best describes the effect of **S2**?

- A** It reduces growth.
- B** It has no effect on growth.
- C** When it is given with other supplements, it can decrease growth.
- D** When it is given with other supplements, it can increase growth.

30 In order to determine the effect on growth of **S1**, of the following, it is best to compare

- A** Trials 1 and 2.
- B** Trials 1 and 9.
- C** Trials 9 and 10.
- D** Trials 9 and 16.

- 31 Which of the following statements is best supported by the data?
- A Growth is decreased when all three supplements are given together.
 - B Growth is decreased when any one of the supplements is given on its own.
 - C When given individually, growth is increased by two of the three supplements.
 - D When given individually, growth is increased by each of the three supplements.
- 32 In order to best determine the effects on growth of S2 and S3 in combination and individually, of the following, it is best to compare
- A Trials 2 and 7.
 - B Trials 4, 5 and 8.
 - C Trials 1, 3, 5 and 7.
 - D Trials 2, 4, 6, 8 and 16.

UNIT 10

Questions 33 – 35

The following questions are from a debate for and against the topic:

Popular entertainers should be banned from appearing in political campaigns.

For each of the questions you are to choose the alternative (A–D) that most appropriately describes the relationship of the statement to the topic of the debate.

The statement

- A is most likely part of the debate **for** the topic.
 - B is most likely part of the debate **against** the topic.
 - C could possibly be part of the debate **for or against** the topic.
 - D **is not relevant** to either the debate for or against the topic.
- 33 When elections are over, celebrities aren't responsible for the promises politicians have made.
- 34 Most politicians aren't interested in popular entertainment.
- 35 Personality is not the same as policy.

UNIT 11

Question 36

Below is the definition of a rule, called the Chatham House Rule, which is used in some meetings.

‘When a meeting, or part thereof, is held under the Chatham House Rule, participants are free to use the information received, but neither the identity nor the affiliation of the speaker(s), nor that of any other participant, may be revealed.’

36 The Chatham House Rule is intended to

- A ensure the accuracy of statements made in a meeting.
- B protect those spoken about in a meeting from being defamed.
- C allow speakers at a meeting to speak without concern for their official positions.
- D protect those spoken about in a meeting from knowing who has been discussing them.

UNIT 12

Question 37

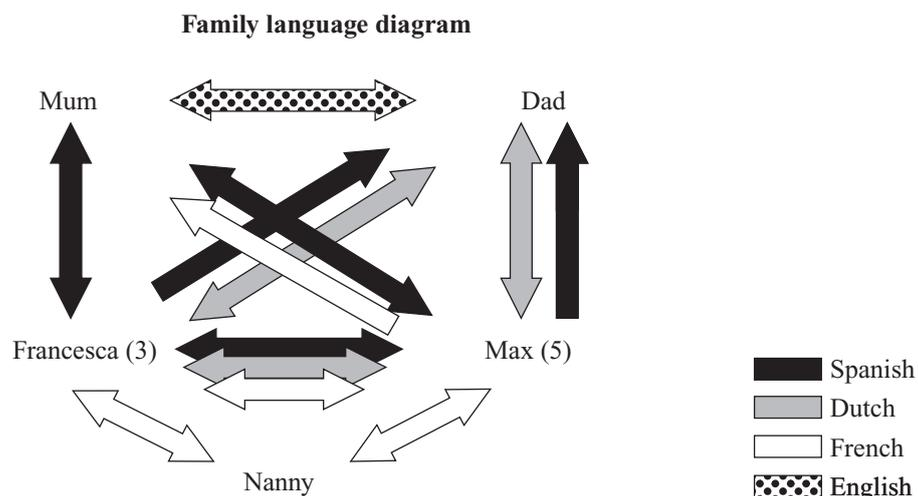

37 Which of the following is true?

- A Francesca can speak to Mum without Dad understanding.
- B Dad can speak to the children without Mum understanding.
- C Mum can speak to the children without Dad understanding.
- D The Nanny can speak to the children without their parents understanding.

UNIT 13

Questions 38 – 42

Produced for the US space program, the figure and accompanying table give certain body size measurements in centimetres for 40-year-old US males when sitting. Each type of measurement is given an identification number (e.g. 758 represents sitting height). Also given for each measurement type are the 5th, 50th and 95th percentile values. For example, the 95th percentile value indicates that 95% of people have a value below this level.

(Note that the figure is not drawn exactly to scale.)

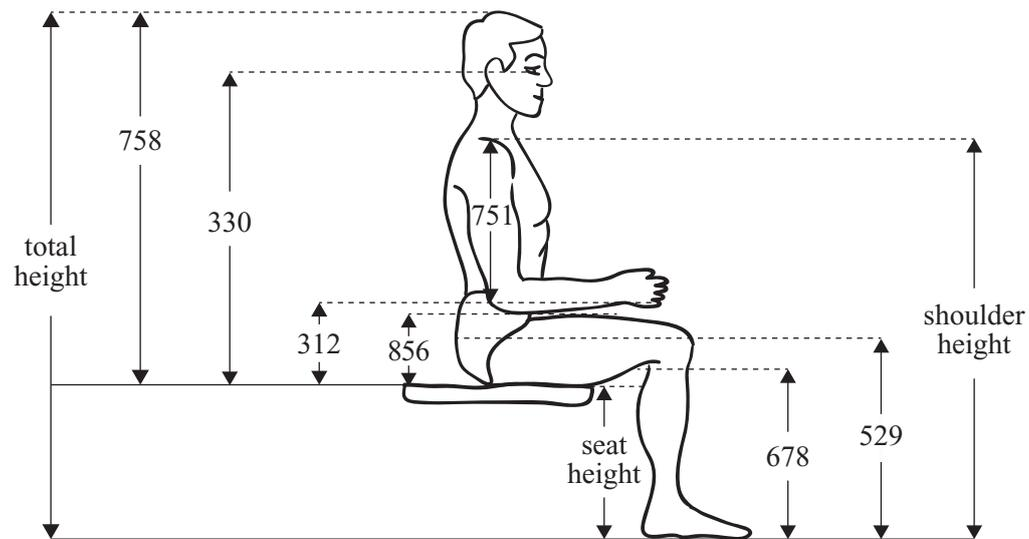

Measurement Identification Number	Height Dimension Measurement	5th percentile (cm)	50th percentile (cm)	95th percentile (cm)
758	Sitting	88.9	94.2	99.5
330	Eye	76.8	81.9	86.9
529	Knee	52.6	56.7	60.9
678	Popliteal	40.6	44.4	48.1
751	Shoulder–elbow	33.7	36.6	39.4
856	Thigh clearance	11.5	16.8	19.1
312	Elbow rest	21.1	25.4	29.7

- 38 For the 50th percentile values, the difference between measurements **312** and **856** is
- A 8.6 cm.
 - B 9.6 cm.
 - C 10.0 cm.
 - D 11.4 cm.
- 39 Suppose a 40-year-old US male has a difference of 12.8 cm between knee height and popliteal height measurements, and all his measurements correspond to the same percentile.
- Which of the following could be the difference between his sitting height and eye height measurements?
- A 11.9 cm
 - B 12.1 cm
 - C 12.3 cm
 - D 12.6 cm
- 40 For the 50th percentile values, the difference between the height of the shoulder above the ground and the height of the seat above the ground
- A is 53.4 cm.
 - B is 57.7 cm.
 - C is 62.0 cm.
 - D cannot be determined from the information provided.
- 41 If two measurements give a difference of 17.8 cm, they could relate to the difference between
- A knee height and eye height for the 95th percentile.
 - B eye height and shoulder height for the 95th percentile.
 - C thigh clearance height and shoulder–elbow height for the 5th percentile.
 - D popliteal height and elbow rest height for the 5th percentile.
- 42 For the 50th percentile values, seat height
- A is 37.9 cm.
 - B is 38.9 cm.
 - C is 39.9 cm.
 - D cannot be determined from the information provided.

UNIT 14

Questions 43 – 47

In this poem, published in 1968, the speaker describes an outer suburb of Sydney.

Outer suburb

Here the ground has been punched flat by the sun,
bitten by wind-storms. The houses are
pastel in fibro¹. Few things seem to belong.
The people walk with a harsh bewildered rhythm.

Twenty miles², a generation, to the east 5
lies Mother City with her prancing harbour,
packed streets that drove us, exiles, to this suburb.
We can't go back. No-one wants to move on.

And the dust crawls, with the monotony of toothache,
up Mittiamo Street. Something in this landscape 10
dries the speech in your throat. All that we have
is our dumb-struck unaccountable need of each other

and the conviction that, come hell or hire-purchase³,
old cats and even families go on living –
while to the north-west, green as witchcraft, 15
the voluptuous smooth hills beckon and taunt.

Craig Powell

¹ *fibro*: fibre-cement sheeting, a cheap building material

² *Twenty miles*: a little over 30 kilometres

³ *hire-purchase*: a system of paying for goods by instalments

- 43 The phrase 'Few things seem to belong' (line 3) suggests the
- A artificiality of the location as a place to live.
 - B fact that people have few possessions of their own.
 - C itinerant nature of the people who live in the suburb.
 - D lack of care with which the inhabitants treat their environment.
- 44 The description of the suburb's people (line 4) reflects
- A the sluggishness that caused their situation.
 - B their reaction to the starkness of the situation.
 - C their innate lack of sensitivity to the situation.
 - D the fierce desire they have to overcome their situation.

- 45 What has happened in the 'Mother City' (line 6) to exile the people to the outer suburb?
When life in the city became
- A too serious, the suburb offered a rustic charm.
 - B predictable, they sought stimulation in the suburb.
 - C unsustainable, the suburb offered a viable alternative.
 - D too materialistic, they sought spirituality in the suburb.
- 46 The speaker suggests that the lure of the hills is
- A soothing and restful.
 - B appealing but illusory.
 - C bizarre and frightening.
 - D menacing but resistible.
- 47 Ultimately the speaker finds the people living in the outer suburb to be both
- A irritating and pathetic.
 - B predictable and erratic.
 - C damaged and enduring.
 - D eccentric and intriguing.

UNIT 15

Questions 48 – 51

C_1 , C_2 , C_3 and C_4 are four outlets belonging to the same chain of cafes. The chain has contracted three companies – S_1 , S_2 and S_3 – to supply the cafes with coffee. According to the contract:

- each cafe must receive a fixed quantity of coffee per month – C_1 : 200 kg; C_2 : 250 kg; C_3 : 200 kg; C_4 : 250 kg,
- each company must supply a fixed quantity of coffee per month – S_1 : 300 kg; S_2 : 350 kg; S_3 : 250 kg.

Because of different transport costs, the amount that each supplier charges each cafe varies, as shown in Table 1.

Table 1

		Cost of supplying coffee (\$/kg)			
		C_1	C_2	C_3	C_4
Supplier	S_1	10	10	20	10
	S_2	10	8	10	10
	S_3	8	10	12	6

Table 2 shows the amount of coffee supplied by each company to each cafe during the first month of the contract.

Table 2

		Amount of coffee supplied to cafe (kg)			
		C_1	C_2	C_3	C_4
Supplier	S_1	200	50	0	50
	S_2	0	200	150	0
	S_3	0	0	50	200

48 How much should supplier S_2 receive from cafe C_2 in the first month of the contract?

- A \$0
- B \$200
- C \$1600
- D \$2100

Questions 49 and 50 refer to the following additional information.

Two possible amendments (A1 and A2) to the original contract have been proposed.

		Amount of coffee to be supplied to each cafe (kg)				
		C ₁	C ₂	C ₃	C ₄	
A1	Supplier	S ₁	100	50	0	150
		S ₂	0	200	150	0
		S ₃	100	0	50	100

		Amount of coffee to be supplied to each cafe (kg)				
		C ₁	C ₂	C ₃	C ₄	
A2	Supplier	S ₁	50	50	0	200
		S ₂	0	200	150	0
		S ₃	150	0	50	50

Note: Neither of the proposed amendments affects cafes C₂ or C₃.

49 The amendments proposed in A2 would cause the total cost of coffee to increase

- A for C₄ but not for C₁.
- B for C₁ but not for C₄.
- C equally for C₁ and C₄.
- D for neither C₁ nor C₄.

50 Which supplier (if any) would have the greatest increase in income from the changes proposed in A1?

- A S₁
- B S₂
- C S₃
- D No supplier

Question 51 refers to the following additional information.

Supplier S₁ wants to alter the amounts of coffee it supplies to cafes C₂ and C₃, without changing the totals agreed to in the original contract. The proposed changes, which do not affect S₃, are shown below.

	C ₁	C ₂	C ₃	C ₄
Amount S ₁ wants to supply (kg)	200	30	20	50

51 How much coffee would S₂ supply to C₂ and C₃ under this arrangement?

- A 220 kg to C₂, 130 kg to C₃
- B 200 kg to C₂, 150 kg to C₃
- C 180 kg to C₂, 170 kg to C₃
- D 160 kg to C₂, 190 kg to C₃

UNIT 16

Question 52

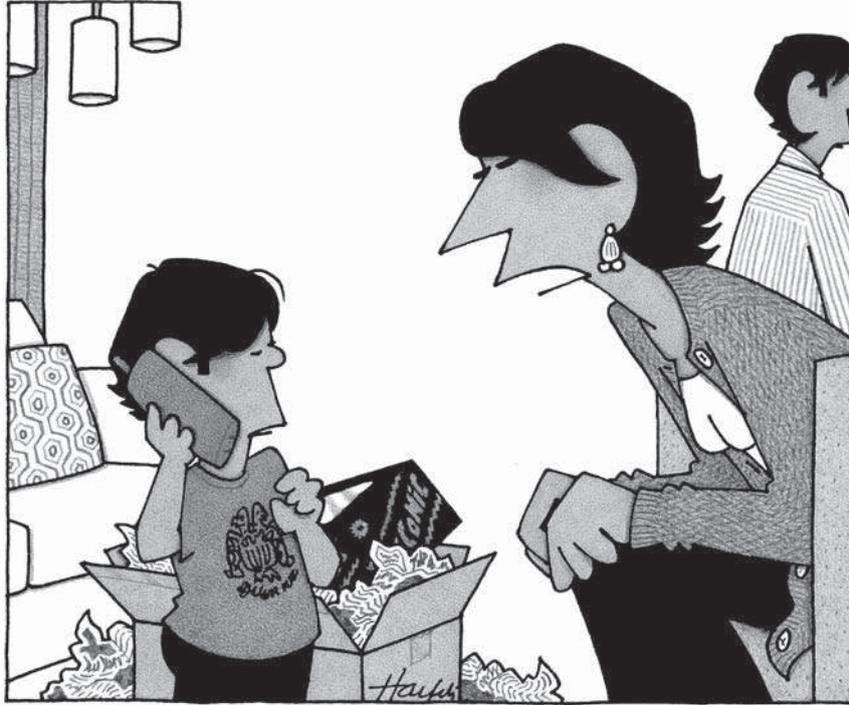

*"Tell your grandfather how much you like his present
and ask him if he still has the receipt."*

- 52 The mother in this cartoon is providing her son with a model for
- A good manners.
 - B glib insincerity.
 - C proper appreciation.
 - D ruthless negotiation.

UNIT 17

Questions 53 – 55

The chart at right gives the order in which nine stages in the construction of a building (M to U) need to be completed. The numbers indicate the minimum length of time (in weeks) required to complete each stage.

As indicated by the arrows, some stages must be completed before work can start on others. However, some stages may be worked on at the same time.

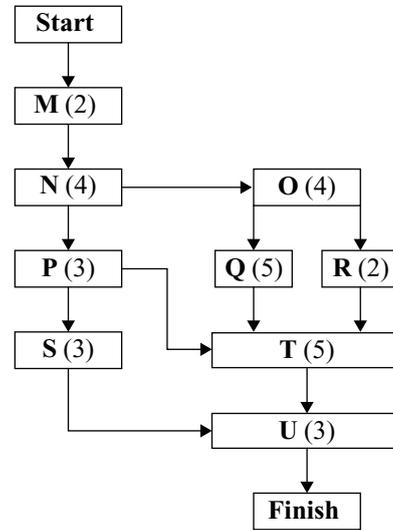

- 53 If all construction is completed in the minimum time, after how many weeks from the start will stage S be completed?
- A eight weeks
 - B ten weeks
 - C twelve weeks
 - D fourteen weeks
- 54 Which of the following stages can be worked on at the same time?
- A N, O and R
 - B R, O and Q
 - C P, Q and R
 - D S, T and U
- 55 What is the minimum length of time needed to complete the building?
- A 23 weeks
 - B 25 weeks
 - C 27 weeks
 - D 29 weeks

UNIT 18

Questions 56 – 59

In the following passage from a novel, Danny, a Tank Commander in the Czechoslovakian army, is a member of a committee that is examining a group of soldiers on their understanding of certain political books. He has just been asked to take a leading role in the examination, after previous examiners on the panel began to worry about the lack of knowledge displayed by the soldiers.

And so Danny was shaken out of the generally pleasant role of amused onlooker, and took the matter into his experienced imposter's hands. To bring the tests to a successful conclusion, he used a method he had perfected in the school in Hronov, whereby information can be elicited from utterly ignorant people.

'And now, comrades, let's analyse the book by Alexander Fadyeyev called *The Young Guard*,' he said. 'As you recall, it's a famous book about the underground resistance of young Soviets against the German occupiers. Now, bearing in mind the title, who led this underground resistance? Sergeant Mácha?' 5

Mácha stood up and said that Soviet youth had led the resistance. Was Soviet youth satisfied with merely passive resistance, or did they struggle actively as well? Tank Commander Hykal replied that their resistance was active as well. Then Danny asked what active resistance was, as opposed to passive resistance, which meant that no acts of sabotage were committed and no guerrilla warfare was waged, and Sergeant Koblíha correctly defined it as resistance in which acts of sabotage were committed; he even added, without being prodded, that the guerrillas also blew up bridges. In this way the committee disposed of *The Young Guard*. 10 15

- 56 Danny is concerned to 'bring the tests to a successful conclusion' (lines 2 and 3). Which of the following is closest to what 'a successful conclusion' means for Danny?
- A finishing within the time limit
 - B unobtrusively teaching the soldiers the material
 - C establishing who knew the material and who did not
 - D creating the impression that all the soldiers knew the material

- 57 'Was Soviet youth satisfied with merely passive resistance, or did they struggle actively as well?' (lines 9 and 10)

For Danny's purposes, the key word in this sentence is

- A youth.
- B merely.
- C passive.
- D resistance.

- 58 The passage as a whole is best described as

- A tragic.
- B earnest.
- C satirical.
- D dramatic.

- 59 The point of the passage is that Danny's questions

- A are too easy.
- B are too hard.
- C give the answers.
- D require an answer.

UNIT 19

Questions 60 – 62

A manufacturer produces triangular black tiles in three sizes: large, medium and small. Figure 1 shows their relative sizes to scale.

Each tile has a right angle between its two shorter sides, and the base (longest side) equals twice the height (straight line distance between the middle of the base and the corner between the two shorter sides).

When the tiles are laid:

- the tiles are not cut or broken,
- the tiles touch each other without gaps between them and do not overlap, and
- the tiled surface is completely covered.

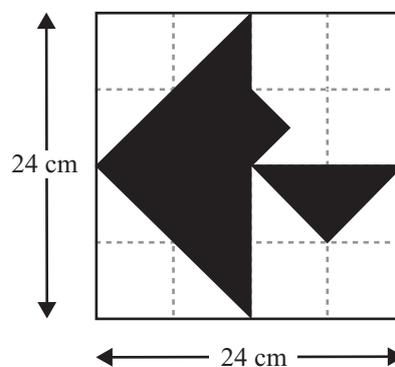
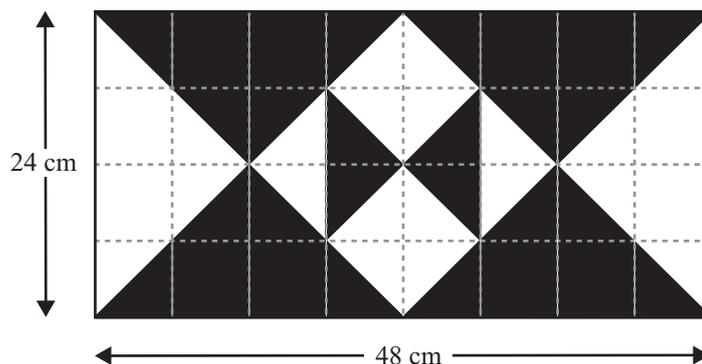

Figure 1

- 60 What is the area of the medium-sized tile?
- A 18 cm^2
 B 36 cm^2
 C 48 cm^2
 D 72 cm^2
- 61 How many large triangles are required to produce a square 36 cm by 36 cm?
- A 8
 B 12
 C 16
 D This cannot be done.

- 62 Consider the following tiled area.



Which of the following combinations of the black tiles will cover the black area with none left over?

- A 0 large, 10 medium, 8 small
- B 2 large, 2 medium, 4 small
- C 2 large, 2 medium, 12 small
- D 2 large, 4 medium, 24 small

UNIT 20

Questions 63 and 64

The following passage is from an autobiography. The writer was born in London of German-Russian parents, was fluent in six languages, travelled extensively, and lived for extended periods in a number of countries.

Due to copyright restriction,
this material is not supplied.

- 63 The writer says that no national anthem has ever brought ‘a lump to my throat’ (line 2). This statement suggests that he
- A is a pacifist.
 - B is not a particularly emotional person.
 - C has a low opinion of nationalistic pride.
 - D likes some national anthems more than others.
- 64 The passage as a whole suggests that when ‘men rise as a mass with a look of inane piety on their faces’ (lines 5 and 6),
- A their logic is at fault but not their emotions.
 - B their emotions are at fault but not their logic.
 - C their logic and their emotions are both at fault.
 - D they are acting logically and their emotions are healthy.

UNIT 21

Questions 65 – 68

Consider the following four flow charts, which use the same input number, x , where x is a positive or a negative integer (but not zero), to produce the numbers I , II , III and IV .

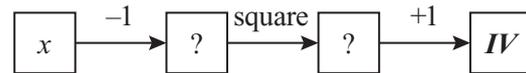
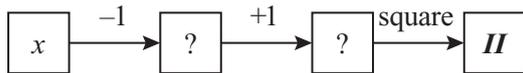
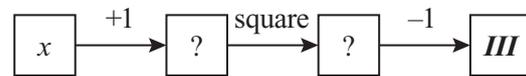
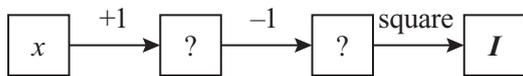

65 If $x > 0$ and $I = 36$, what is x ?

- A 4
- B 6
- C 7
- D 8

66 Which of the following is always true?

- A $I = II$ only
- B $III = IV$ only
- C $I = II$ and $III = IV$, but $II \neq III$
- D $I = II = III = IV$

67 When $x > 0$, which of the following is always true?

- A $x = \sqrt{IV - 1} + 1$
- B $x = \sqrt{IV + 1} - 1$
- C $x = (IV + 1)^2 - 1$
- D $x = (IV - 1)^2 + 1$

68 If $x < 0$ and $I = 64$, what is the value of IV ?

- A 48
- B 50
- C 80
- D 82

UNIT 22

Questions 69 and 70

This unit concerns a painting and a photograph. The painting was created in America during the 1930s. It was a time when the Great Depression had crippled the economy and the mid-western states had become what were known as ‘dustbowls’ as a consequence of drought and unsustainable farming practices. The photograph was taken at this time.

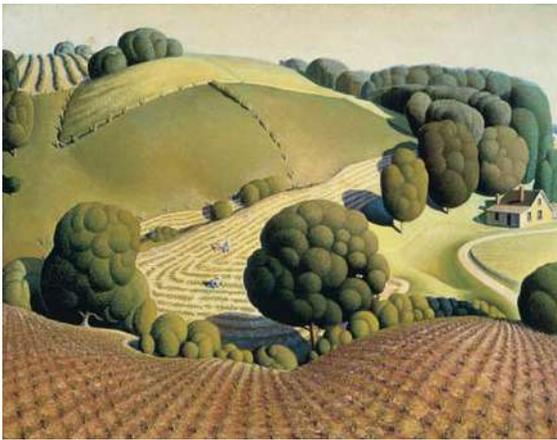

Dorothea Lange, 1938; US Farm Security Administration/Office of War Information
(Library of Congress, Prints and Photographs Division Washington, DC)

69 It has been said that the painting is ‘gently satiric’.

The impression of gentleness is most clearly conveyed by the

- A predominance of curves.
- B use of brown colouring in the foreground.
- C straight lines in the foreground and background.
- D contrast of the tiny farm labourers with their surroundings.

70 The photograph provides a stark contrast to all of the following features of the painting **except** one. Which one?

- A the rolling hills
- B the health of the crops
- C the availability of water
- D the style of the farmhouse

This publication may contain copyright material belonging to a third-party. Every effort has been made to contact all copyright owners. If you believe that material in this publication is an infringement of your copyright please email the Copyright Officer:

vcaa.copyright@edumail.vic.gov.au

ACKNOWLEDGMENTS — Defense Imagery, US Department of Defense for the photograph ‘U.S. Coast Guard rescue swimmer Petty Officer 3rd Class Christopher Wheeler radios to the crew of an HH-65 Dolphin helicopter during a search and rescue mission in Fargo, N.D., on March 26, 2009’; the image of the Parkes Radio Telescope is reproduced by permission of Dr Shaun Amy, CSIRO; the image of Nikola Tesla ‘Columbia College Demonstration New York, 1891’ is from *Electrical World*, May 20, 1891; the radio waves diagram is based on original artwork from the National Earth Science Teachers Association’s *Windows to the Universe* (http://www.windows2universe.org/physical_science/magnetism/em_radio_waves.html); the cartoon ‘We’ve been thinking a lot about what we want to do with your life’ © David Sipress / The New Yorker Collection / www.cartoonbank.com; Helen Brack for permission to use John Brack’s painting *The Car*; the Defibrillation diagram is from the website of the City of Rochester, Minnesota, Police Department Early Defibrillation Program (<http://www.rochestermn.gov/departments/police/defibrillation/index.asp>); the poem ‘Outer suburb’ is reproduced by permission of Craig Powell and South Head Press; the cartoon ‘Tell your grandfather how much you like his present and ask him if he still has the receipt’ © William Haefeli / The New Yorker Collection / www.cartoonbank.com; the excerpt from *The Republic of Whores* by Josef Skvorecky, translated from the Czech by Paul Wilson (The Ecco Press, 1994), by permission of the translator; the excerpt from *Dear Me* by Peter Ustinov, published by William Heinemann, was reprinted by permission of The Random House Group Limited; Grant Wood’s 1931 painting *Young Corn* (Oil on Masonite panel, 24 x 29 7/8 in.) is in the Collection of the Cedar Rapids Community School District, on loan to the Cedar Rapids Museum of Art; the photograph ‘Dust Bowl Farm Coldwater District, Texas’ by Dorothea Lange, 1938, is from the Library of Congress Prints and Photographs Division Washington, DC 20540 <http://hdl.loc.gov/loc.pnp/pp.print> and is in the public domain, having been commissioned by the United States Farm Securities Administration - work done for/by the US government is not protected by copyright.

